



ON Semiconductor®

<http://onsemi.com>

# LA72702NV

## Monolithic Linear IC BTSC Decoder for US TV

### Overview

The LA72702NV is a US TV BTSC Decoder.

### Features

- With SIF circuit, alignment-free\* STEREO channel separation.
- \* When base band signal input, separation is adjusted by input level.
- Dual slave address(80h, 84h).

### Functions

- SIF FM-Demodulator
- STEREO detection
- STEREO decoder
- STEREO detection sensitivity change function
- dbx Noise Reduction
- SAP demodulator
- SAP detection
- SAP output select 2-levels
- SAP detection sensitivity change function

### Specifications

#### Maximum Ratings at Ta = 25°C

Parameter	Symbol	Conditions	Ratings	Unit
Maximum power supply voltage	V <sub>CC</sub> H max		7.0	V
Allowable power dissipation	Pd max	Ta ≤ 85°C, Mounted on a specified board*	290	mW
Operating temperature	Topr		-20 to +85	°C
Storage temperature	Tstg		-55 to +150	°C

\* Mounted on a specified board: 114.3mm×76.1mm×1.6mm, glass epoxy board

Stresses exceeding Maximum Ratings may damage the device. Maximum Ratings are stress ratings only. Functional operation above the Recommended Operating Conditions is not implied. Extended exposure to stresses above the Recommended Operating Conditions may affect device reliability.

#### Operating Conditions at Ta = 25°C

Parameter	Symbol	Conditions	Ratings	Unit
Recommended operating voltage	vacate		5.0	V
Allowable operating voltage range	V <sub>CC</sub> H op		4.5 to 5.5	V

# LA72702NV

**Electrical Characteristics** at Ta = 25°C, V<sub>DD</sub> = 5.0V

Parameter	Symbol	Conditions	Ratings			Unit
			min	typ	max	
Current dissipation	I <sub>CC</sub>	No signal Inflow current at pin 19, default condition	30	40	50	mA
SIF input level (Reference)	V <sub>LIM</sub>	f <sub>c</sub> = 4.5MHz Deviation MONO (300Hz, Mod = 100%, Pre-emphasis ON) → ±25kHz	(80)	(90)	(100)	dBμV
Base band input level (Reference)	V <sub>LIMB</sub>	100% Modulation MONO(L+R) : 530mVp-p (300Hz, Pre-emphasis ON) SUB(L-R) : 380mVp-p (300Hz, dbx-NR ON), Pilot : 110mVp-p SAP : 300mVp-p (300Hz, dbx-NR ON)				
MONO output level	V <sub>OMON</sub>	f <sub>m</sub> =1kHz, 100% Mod, 15kHz LPF	-7.0	-5.5	-4.5	dBV
MONO distortion	THDMON	f <sub>m</sub> =1kHz, 100% Mod, 15kHz LPF		0.15	0.6	%
MONO frequency characteristics	FCM1	f <sub>m</sub> =3kHz, 30% Mod, Pre-emphasis ON * Measure ratio from f <sub>m</sub> =1kHz level.	-2	0	2	dB
MONO S/N ratio	SNM	S=V <sub>OMON</sub> , N=0% Mod, 15kHz LPF	55	65		dB
STEREO output level	V <sub>O</sub> ST	f <sub>m</sub> =1kHz, 100% Mod, 15kHz LPF	-7.0	-5.5	-4.5	dBV
STEREO distortion	THDS	f <sub>m</sub> =1kHz, 100% Mod, 15kHz LPF		0.5	1.0	%
STEREO frequency characteristics	FCS1	f <sub>m</sub> =3kHz, 30% Mod, 15kHz LPF * Measure ratio from f <sub>m</sub> =1kHz level.	-2	0	2	dB
STEREO S/N ratio	SNS	S=V <sub>O</sub> ST, N=0% Mod, 15kHz LPF	50	60		dB
STEREO separation 1	STSE1	f=300Hz (R/L), 30% Mod, 15kHz LPF	20	25		dB
STEREO separation 2	STSE2	f=3kHz (R/L), 30% Mod, 15kHz LPF	20	25		dB
STEREO Detection level-1	V <sub>INSD1</sub>	Except Stereo Detection → Stereo Detection * Serial control "SENS HI" Pilot (fH)=15.73kHz * Measure pilot level.	30	38	45	%
STEREO Detection level-2	V <sub>INSD2</sub>	Except Stereo Detection → Stereo Detection * Serial control "SENS LO"	38	47	53	%
STEREO Detection hysteresis	HYST	Input Mod. Difference at Stereo/Except Stereo Det. * Serial control "SENS HI"	10	20	30	%
SAP output level-1	V <sub>O</sub> SA1	f <sub>m</sub> =1kHz, 100% Mod, 15kHz LPF * SAP-1 (serial control)	-14.0	-11.0	-8.0	dBV
SAP output level-2	V <sub>O</sub> SA2	f <sub>m</sub> =1kHz, 100% Mod, 15kHz LPF * SAP-2 (serial control)	-7.5	-5.5	-3.5	dBV
SAP distortion	THDSA	f <sub>m</sub> =1kHz, 100% Mod, 15kHz LPF		0.7	1.5	%
SAP S/N ratio	SNSA	S=V <sub>O</sub> SA2, N=0% Mod, 15kHz LPF	50	60		dB
SAP detection level-1	V <sub>INSA1</sub>	Except SAP → SAP Det. * Serial control "SENS HI" SAP Carrier=5fH only * Measure output level.	10	17	24	%
SAP detection level-2	V <sub>INSA2</sub>	Except SAP → SAP Det. * Serial control "SENS LO" * Measure output level.	17	24	31	%
SAP detection hysteresis	HYSA	Input Mod. Difference at SAP/Except SAP Det. * SAP carrier only. * Serial control "SENS HI"	2	5	10	%
MODE output MONO	MODMO	Input=MONO : f=1kHz, 0% Mod	0.7	1	1.3	V
MODE output SAP	MODSA	Input=SAP : Carrier	1.6	1.9	2.2	V
MODE output STEREO	MODST	Input=STEREO : Pilot	2.5	2.8	3.1	V
MODE output ST + SAP	MODSS	Input=STEREO : Pilot, SAP : Carrier	3.5	3.8	4.2	V
Stereo detect speed (Reference )	STDT	Input=STEREO : Pilot I <sup>2</sup> C data no-send Measure pin 20 voltage change to 2.8V timing from Power ON		(480)	(1000)	ms
SAP detect speed (Reference )	SAPDT	SAP : Carrier I <sup>2</sup> C data no-send Measure pin 20 voltage change to 1.9V timing from Power ON		(350)	(1000)	ms

\* Normally measurement condition is Input = SIF mode (90dBμV)

\* " Reference " Items are reference levels, their specs are no-guarantee.

# LA72702NV

## Package Dimensions

unit : mm (typ)  
3175C

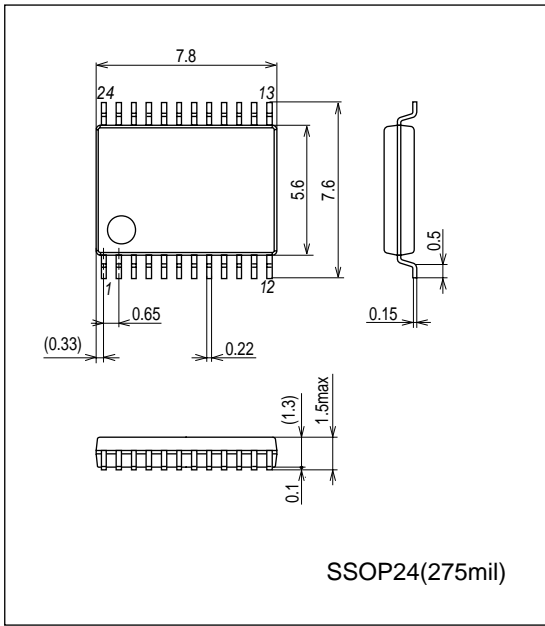

## Mode Condition

Signal	I <sup>2</sup> C data in									Output mode			I <sup>2</sup> C out		Mode pin20
	D8	D7	D6	D5	D4	D3	D2	D1	Lch pin18	Rch pin17	Mode condition	D8	D7		
Stereo + SAP	(0)	(0)	*	(0)	(0)	0	0	0	L	R	Stereo	1	1	3.8V	
	FIX	SIF (1) BASE band	0	STEREO	SAP	0	0	1	SAP	SAP	SAP-1				
			1	SENS	SENS	0	0	1	SAP	SAP	SAP-2				
			0	Lo	Lo	0	1	0	L+R	SAP	MULTI-1				
			1	(1)	(1)	0	1	0	L+R	SAP	MULTI-2				
			*	Hi	Hi	1	0	0	L+R	L+R	F-MONO				
			*			1	0	1	L+R	L+R	F-MONO				
			*			1	1	0	L+R	L+R	F-MONO				
			*			*	1	1	Off	Off	MUTE				
			*												
Stereo			*			0	0	0	L	R	Stereo	1	0	2.8V	
			*			0	0	1	L	R	Stereo				
			*			0	1	0	L	R	Stereo				
			*			1	0	0	L+R	L+R	F-MONO				
			*			1	0	1	L+R	L+R	F-MONO				
			*			1	1	0	L+R	L+R	F-MONO				
			*			*	1	1	Off	Off	MUTE				
			*												
Mono + SAP			*			*	0	0	L+R	L+R	MONO	0	1	1.9V	
			0			0	0	1	SAP	SAP	SAP-1				
			1			0	0	1	SAP	SAP	SAP-2				
			0			0	1	0	L+R	SAP	MULTI-1				
			1			0	1	0	L+R	SAP	MULTI-2				
			*			*	1	1	Off	Off	MUTE				
			*												
MONO			*			*	0	0	L+R	L+R	MONO	0	0	1.0V	
			*			*	0	1	L+R	L+R	MONO				
			*			*	1	0	L+R	L+R	MONO				
			*			*	1	1	Off	Off	MUTE				

\* : no care

# LA72702NV

## I<sup>2</sup>C Control Table

Grp-1 (Normally use : group-1 only)

D8	D7	D6	D5	D4	D3	D2	D1	Condition
*						0	0	Stereo
						0	1	SAP
						1	0	Both
						1	1	MUTE
*					0			Normal (Auto DET)
					1			Forced Mono
*				0				SAP SENS LO
				1				SAP SENS HI
*			0					Stereo SENS LO
			1					Stereo SENS HI
*		0						SAP Level-1
		1						SAP Level-2
*	0							SIF mode
	1							Base Band mode
*	0							Fix
	1							Prohibit (TEST MODE)

\* : Shows Initial condition

## Read out data

D8	D7	D6	D5	D4	D3	D2	D1	Condition
		0	0	0	0	0	0	Fixed
	0							Normal
	1							SAP det
0								Normal
1								Stereo det

## Test mode condition(Reference)

When STOP condition transform at Grp-1 data-end, controlled NORMAL mode.

Grp-2 is only test condition. Usually, these data are no-need. Their data are no guarantee, except all L condition.

D8	D7	D6	D5	D4	D3	D2	D1	Condition/Monitor position
0	0	0	0	0	0	0	0	Normal (Usually, Fixed)
				0	0	0	1	TEST-1 SIF output
				0	0	1	0	TEST-2 SAP BPF
				0	0	1	1	TEST-3 (reserved)
				0	1	0	0	TEST-4 ST VCO
				0	1	0	1	TEST-5 (reserved)
				0	1	1	0	TEST-6 SAP monitor
				0	1	1	1	TEST-7 ST monitor
				1	0	0	0	TEST-8 Pilot cancel monitor
				1	0	0	1	TEST-9 dbx 2.19k LPF
				1	0	1	0	TEST-10 dbx 408 LPF
				1	0	1	1	TEST-11 dbx DET 10k LPF
				1	1	0	0	TEST-12 dbx SPEC 7.6k LPF
				1	1	0	1	TEST-13 dbx SPEC output
				1	1	1	0	TEST-14 L+R/IL-R monitor
				1	1	1	1	TEST-15 dbx 2.09k LPF

Blank Bits are no-care

Slave addresses are 80h (1000 000\*, at pin8 Open/GND) and 84h (1000 010\*, at pin8 H).

Block Diagram and Application

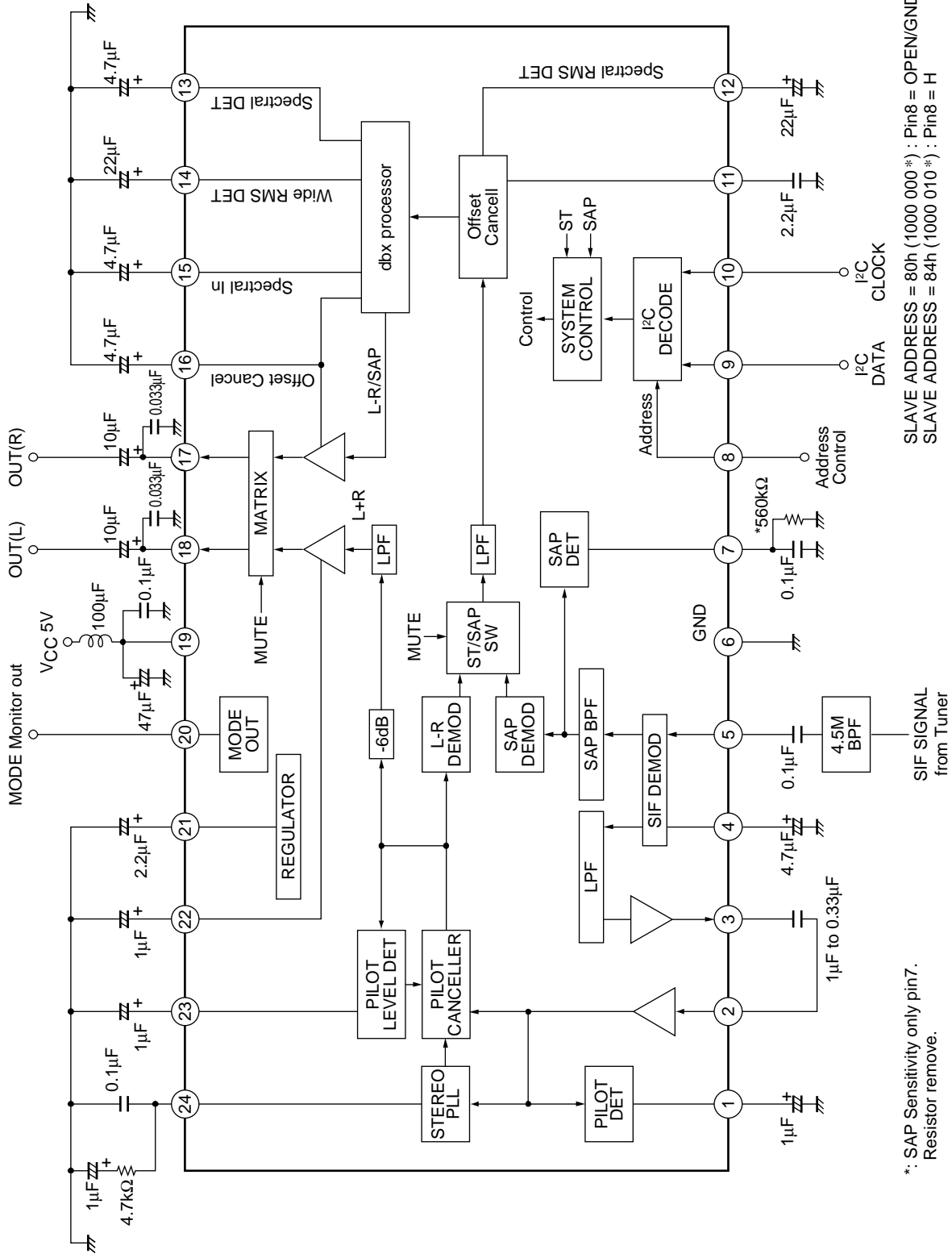

# LA72702NV



## Pin Functions

Pin No.	Pin Name	Function	DC: voltage AC: level	Equivalent Circuit
1	PCPLDET	Pilot level detect for stereo detection	DC : 2.4V	
2	PC_DC_IN	AC coupling (Input)	DC : 2.4V AC : 2.4Vp-p	
3	PC_DCOUT	AC coupling (Output)	DC : 2.4V AC : 2.4Vp-p	
4	PC FIL	SIF offset cancel	DC : 2.6V	
5	PISIF	Signal input Common input at SIF, Base band	DC : 3.7V	
6	GND			
7	CSAPDET	SAP carrier level detect for SAP detection	DC : 2.8V	
8	ADDSEL	Slave address change control  OPEN/GND : 80h 5V : 84h	DC : 0V	

Continued on next page.

# LA72702NV

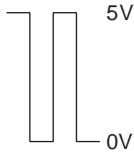
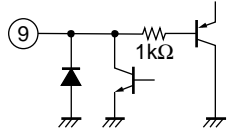
Continued from preceding page.

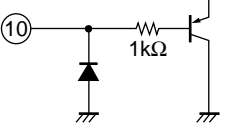
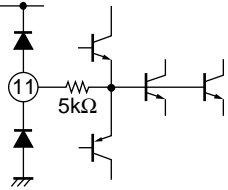
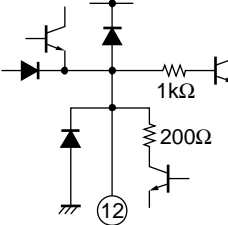
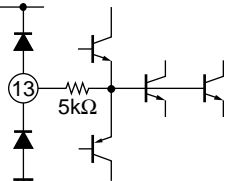
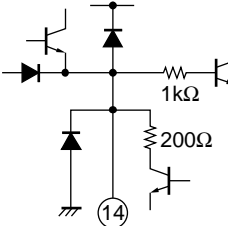
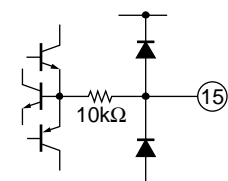
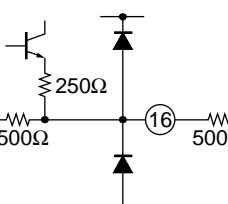
Pin No.	Pin Name	Function	DC: voltage AC: level	Equivalent Circuit
9	SDA	Serial data input	 5V 0V	
10	SCL	Serial clock input	 5V 0V	
11	PC DBXIN	Offset cancel feedback filter	DC: 2.4V	
12	PCDETSPE	Spectral band RMS detect	DC: 2.3V	
13	PCTIMSPE	dbx spectral detect	DC: 2.4V	
14	PCTNWID	Wide band RMS detect	DC: 2.4V	
15	PCSPECIN	dbx main signal V/I convert filter	DC: 2.4V	
16	PC KE6B	Offset cancel feedback filter	DC: 2.4V AC: 220mVp-p	

Continued on next page.

# LA72702NV

Continued from preceding page.

Pin No.	Pin Name	Function	DC: voltage AC: level	Equivalent Circuit
17	PORCH	Line out R	DC: 2.4V AC: 1.4Vp-p	
18	POLCH	Line out L	DC: 2.4V AC: 1.4Vp-p	
19	V <sub>CC</sub>			
20	POLED	Mode out MONO = 0.9V SAP = 2.0V STEREO = 3.0V STEREO + SAP = 3.8V	DC: See Right AC: Test only	
21	PCREG	Reference voltage	DC: 2.4V	
22	PMAINOUT	Offset cancel feedback filter	DC: 1.6V	
23	PCPLC	Pilot level detect for pilot canceller	DC: 2.4V	

Continued on next page.



# LA72702NV

Continued from preceding page.

Pin No.	Pin Name	Function	DC: voltage AC: level	Equivalent Circuit
24	PCPTFLT	Pilot level detect for ST PLL filter	DC: 2.4V	

## I<sup>2</sup>C BUS Serial Interface Specification

### (1) Data transfer manual

This IC adopts control method (I<sup>2</sup>C-BUS) with serial data, and controlled by two terminals which called SCL (serial clock) and SDA (serial data). At first, set up <sup>\*1</sup> the condition of starting data transfer, and after that, input 8 bit data to SDA terminal with synchronized SCL terminal clock. The order of transferring is first, MSB (the Most Scale of Bit), and save the order. The 9th bit takes ACK (Acknowledge) period, during SCL terminal takes 'H', this IC pull down the SDA terminal. After transferred the necessary data, two terminals lead to set up and of <sup>\*2</sup> data transfer stop condition, thus the transfer comes to close.

\*1 Defined by SCL rise down SDA during 'H' period.

\*2 Defined by SCL rise up SDA during 'H' period.

### (2) Transfer data format

After transfer start condition, transfers slave address (1000 000\*) to SDA terminal, control data, then, stop condition (See figure 1).

Slave address is made up of 7bits, <sup>\*3</sup>8th bit shows the direction of transferring data, if it is 'L' takes write mode (As this IC side, this is input operation mode), and in case of 'H' reading mode (As this IC side, this is output operation mode). Data works with all of bit, transfer the stop condition before stop 8bit transfer, and to stop transfer, it will be canceled the transfer dates.

\*3 It is called R/W bit.

Fig.1 DATA STRUCTURE "WRITE" mode

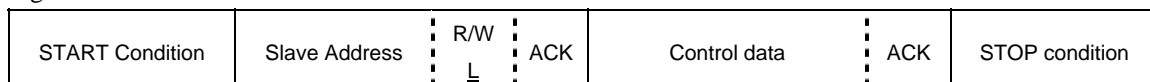
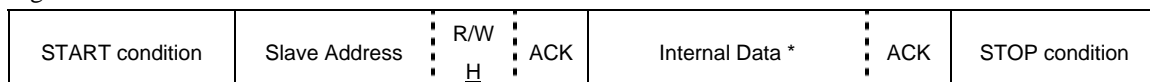

Fig.2 DATA STRUCTURE "READ" mode



\* The output data synchronizes with the clock of SCL pin. Then, the ACK output is made after the output data.

bit8 is result of STERO DET (H : STEREO)

bit7 is result of SAP DET (H : SAP)

bit6 to bit1 are fixed to 'L'

### (3) Initialize

This IC is initialized for circuit protection. Initial condition is "0 (All bits)".

# LA72702NV

## Reference

Parameter	Symbol	min	max	unit
LOW level input voltage	$V_{IL}$	-0.5	1.5	V
HIGH level input voltage	$V_{IH}$	2.5	5.5	V
LOW level output current	$I_{OL}$		3.0	mA
SCL clock frequency	$f_{SCL}$	0	100	kHz
Set-up time for a repeated START condition	$t_{SU : STA}$	4.7		$\mu s$
Hold time START condition. After this period, the first clock pulse is generated	$t_{HD : STA}$	4.0		$\mu s$
LOW period of the SCL clock	$t_{LOW}$	4.7		$\mu s$
Rise time of both SDA and SDL signals	$t_R$	0	1.0	$\mu s$
HIGH period of the SCL clock	$t_{HIGH}$	4.0		$\mu s$
Fall time of both SDA and SDL signals	$t_F$	0	1.0	$\mu s$
Data hold time	$t_{HD : DAT}$	0		$\mu s$
Data set-up time	$t_{SU : DAT}$	250		ns
Set-up time for STOP condition	$t_{SU : STO}$	4.0		$\mu s$
BUS free time between a STOP and START condition	$t_{BUF}$	4.7		$\mu s$

## Definition of timing

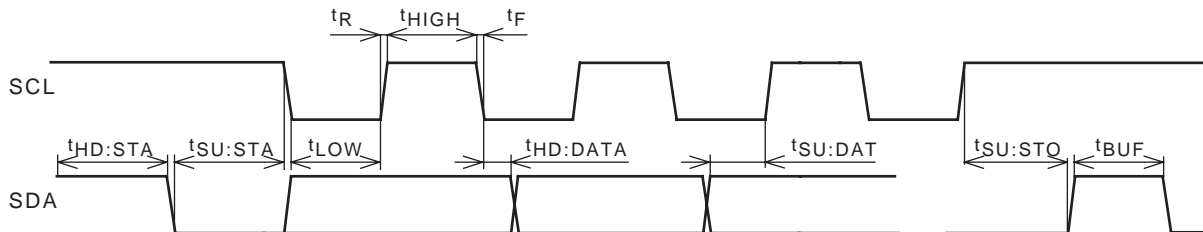

ON Semiconductor and the ON logo are registered trademarks of Semiconductor Components Industries, LLC (SCILLC). SCILLC owns the rights to a number of patents, trademarks, copyrights, trade secrets, and other intellectual property. A listing of SCILLC's product/patent coverage may be accessed at [www.onsemi.com/site/pdf/Patent-Marking.pdf](http://www.onsemi.com/site/pdf/Patent-Marking.pdf). SCILLC reserves the right to make changes without further notice to any products herein. SCILLC makes no warranty, representation or guarantee regarding the suitability of its products for any particular purpose, nor does SCILLC assume any liability arising out of the application or use of any product or circuit, and specifically disclaims any and all liability, including without limitation special, consequential or incidental damages. "Typical" parameters which may be provided in SCILLC data sheets and/or specifications can and do vary in different applications and actual performance may vary over time. All operating parameters, including "Typicals" must be validated for each customer application by customer's technical experts. SCILLC does not convey any license under its patent rights nor the rights of others. SCILLC products are not designed, intended, or authorized for use as components in systems intended for surgical implant into the body, or other applications intended to support or sustain life, or for any other application in which the failure of the SCILLC product could create a situation where personal injury or death may occur. Should Buyer purchase or use SCILLC products for any such unintended or unauthorized application, Buyer shall indemnify and hold SCILLC and its officers, employees, subsidiaries, affiliates, and distributors harmless against all claims, costs, damages, and expenses, and reasonable attorney fees arising out of, directly or indirectly, any claim of personal injury or death associated with such unintended or unauthorized use, even if such claim alleges that SCILLC was negligent regarding the design or manufacture of the part. SCILLC is an Equal Opportunity/Affirmative Action Employer. This literature is subject to all applicable copyright laws and is not for resale in any manner.